

Love of life begins with "Rcom"

# DELUXE MARU

Ver. 4.5

## DIGITAL EGG INCUBATOR USER'S MANUAL

**MARU DELUXE MAX 190 / 380 / 1000 (Cradle Type)**  
**MARU DELUXE MAX 100 / 200 / 300 / 500 (Slide Type)**



# Rcom



### How to use Rcom MARU DELUXE MAX 190 / 380 / 1000 / 100 / 200 / 300 / 500

<b>1. Introduction</b>	
(1) Rcom MARU Introduction	3 ~ 7
(2) Safety precautions	
(3) Identification of Parts and Composition	
(4) Name & Function of Operation Parts	
<b>2. Before use</b>	
(1) What is an Incubation Room?	8 ~ 10
(2) How to install this Incubator	
<b>3. Incubation</b>	
(1) Preparing for Incubation / How to Start Incubation	11 ~ 15
(2) Egg Turning, Humidification, and how to Terminate Incubation	
(3) Humidity and Condensation principles, Air Flow considerations, and Post-Hatch maintenance, Dew Condensation	
<b>4. MARU Function Settings</b>	
(1) Return to Factory Settings	16 ~ 20
(2) Temperature and Humidity Settings	
(3) The Abnormal High and Low Alarm Settings	
(4) How to change between Centigrade and Fahrenheit Temperature units	
(5) Egg Turning options: OFF/ON/1hour/2 hour/3 hour turning/Cycle Setting	
(6) Sound ON /OFF	
(7) Room Light ON/OFF Setting	
<b>5. How to Clean your MARU</b>	
(1) Instructions for Disassembling and Cleaning	21 ~ 22
<b>6. Product Information</b>	
(1) How to Service your Maru Replacing the Fuse, General maintenance	23 ~ 26
(2) Troubleshooting(FAQ)	
(3) Specification	

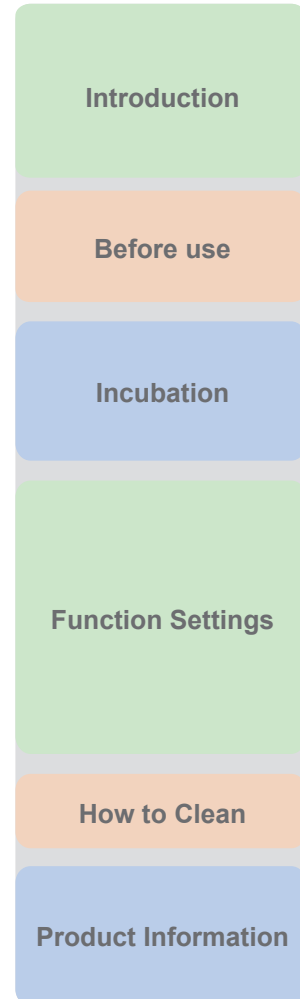

**!** Successful hatching depends on many numbers of factors. Neither Autoelex (Rcom) nor its global distributors and vendors can be held responsible for loss of life or property damage caused by user neglect, alteration, modification or painting, change of use or power failure. To avoid errors, mishaps and danger, carefully check this User Manual before initial use. Also please check the manual regularly to ensure your operation of the machine is correct.

#### Mark Explanation



**Caution :** Caution mark against a fault that can cause damage, trouble, or failure of incubation.



Prohibited.



It is necessary to keep.



Do not disassemble.



Remove the power cord from outlet.



Do not touch.



Ground Connection for preventing electric shock.



**Tip :** References or useful suggestions in using Rcom product



**CAUTION** Warning of actions which may be dangerous or cause damage to the incubator.

### Rcom MARU

Firstly, we sincerely thank you for purchasing Rcom MARU incubators. It has been designed to analyze airflow using built in digital technology to maintain an optimal environment within the incubator cabinet. The incubation parameters are controlled using purpose built control systems coupled with high end sensors, all in order to permit optimum results. However, best results occur when the user, couples personal knowledge of the machine and of incubation and hatching along with observation skills with the Maru Incubators sensing, automation and control systems. The machine needs your help, good breeding flock, healthy flock diet, fertile eggs, reasonable incubation room environment and a 'clean' power supply in order to provide excellent results. User's knowledge of the machine and manage the incubator are very important. Certainly, the Maru provides an optimal incubation environment but parameters need to be managed, i.e. temperature and humidity depends on egg species, environment, and capacity. Moreover, the Rcom MARU has been carefully designed to provide an optimal setting and or hatching environment, therefore, before using the incubator, we strongly recommend that you read the manual carefully.

### Features of Rcom MARU

#### [Main Function]

- \* Convenient jog dial operation for optimized user interface
- \* Integrated simple control panel (superior maintenance)
- \* Automatic temperature & humidity control and set function
- \* Automatic egg turning & turning interval set function (1h, 2h, 3h)
- \* FND display for easy recognition of incubation state
- \* Artificial intelligence electronic control system by Rcom technology
- \* Precise temperature and humidity sensor produced by Sensirion, Swiss (ver. 3rd Generation of Sensirion, Swiss)
- \* Transparent double insulated viewing window
- \* Sliding vent to in the chamber
- \* Dependable temperature by Rcom optimum air flow technology
- \* Innovative PTC Heating Type humidifier eliminates bacteria from humidity reservoir
- \* Built-in water level sensing switch automatically detect the water level inside the humidifier and alarm water refill is required
- \* Increased temperature stability and energy efficiency due to high-density insulated body developed by Rcom
- \* Built-in 'open door' micro-switch detection
- \* Option to select ON/OFF function each of eggs on the universal tray ※ Slide Type

#### [Useful Function]

- \* Degree C / degree F interchangeable
- \* Separate humidifier not required due to built-in humidifier unit within the device
- \* Warning & display function of abnormal temperature caused by ambient temperature fluctuation
- \* Incubation data memory and alarm function in case of blackout
- \* Equipped with water nipple in front for efficient water supply
- \* Equipped with removable upper cover for convenience of cleaning or maintenance after incubation
- \* Built in LED dome-light for ease of viewing when door is open
- \* Automatic horizontal positioning stop function and manual location adjustment function for effortless tray removal ※ Cradle Type
- \* Adjustable universal egg trays suitable for a variety of egg sizes (sold separately) ※ Cradle Type
- \* Perform separate egg rotations by level ※ Cradle 1000 Type
- \* Universal tray sliding device for uniform egg incubation ※ Slide Type
- \* Automatic egg rotation at any angle carried out by tray carrier filler ※ Slide Type
- \* Built-in combination tray for hatching and brooding ※ Slide Type
- \* Adjustable universal tray and aluminum dividers suitable for most egg sizes ※ Slide Type

#### [Sold Separately]

- \* Universal Egg Basket and ABS Divider ※ Cradle Type

### Electrical hazards

**CAUTION** Be careful the details below when you use.

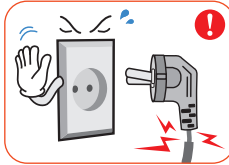

Do not use a damaged power cord or loose outlet.  
▶ Risk of electric shock or fire.

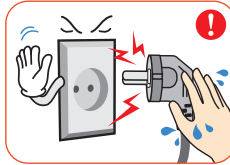

Do not pull the cord when taking out the power cord, and keep wet hands away from connecting plug.  
▶ Risk of electric shock or fire.

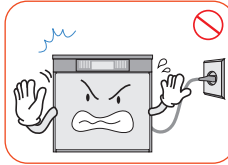

Never pull the plug out of the outlet during the incubation period.  
▶ Incubation will be interrupted.

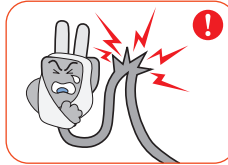

Do not twist or crush electric cord.  
▶ Risk of electric shock or fire.

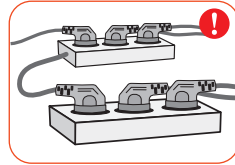

Do not insert multiple connecting plugs in an outlet.  
▶ Risk of fire or electrical overload.

### Setting Cautions

**CAUTION** Be careful the details below when you use.



Do not install in dusty or dirty environment.  
▶ Risk of damage or fire within the incubator.

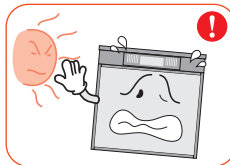

Do not install under the direct sunlight.  
▶ Risk of fire or interference with the incubation process.

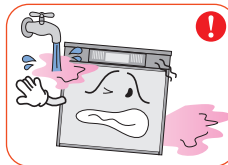

Do not install in moist or humid environment.  
▶ Risk of fire or electric shock.



Do not install in excessively cold or hot conditions, cigarette smoke, etc.  
▶ Risk of interference with the incubation process.

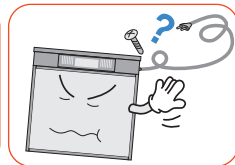

Do not use any other non-standard parts except those provided.  
▶ Risk of damage or hatching failure.

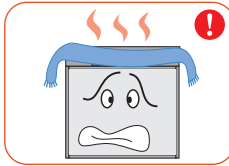

Do not cover the ventilating opening.  
▶ Inner temperature can rise, interrupting incubation.



Install away from heat sources.  
▶ Risk of damage to the incubator case and interference with the incubation process.



Ensure that the incubator is installed on a stable surface away from edges.  
▶ Risk of damage to incubator and eggs and user from accidental knocks or drops.

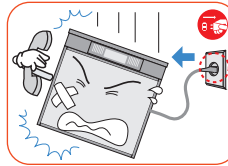

If the incubator requires repair disconnect from the power supply and please contact to your service center.

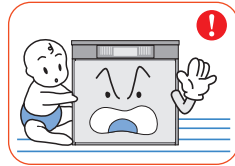

Children should be supervised to ensure that they do not play with the appliance.  
▶ Risk of knocking the incubator or accidental interference with the controls.



Do not disassemble or modify the incubator in any way.  
▶ Risk if electric shock or fire.

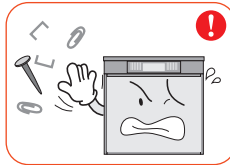

Please ensure that no small objects get into the holes on the incubator.  
▶ Risk of electric shock or fire.

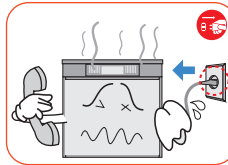

If the incubator sounds strange or emits smoke contact your service center.  
▶ Risk of electric shock or fire.



Clean the incubator thoroughly before storing.

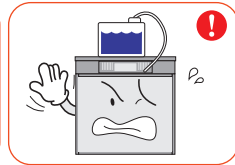

Do not place water container on the incubator

### Cleaning Cautions

**CAUTION** Be sure to disconnect the electric cord from the outlet before cleaning.

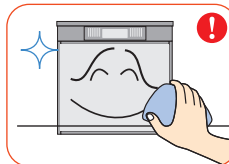

Clean the incubator by a soft cloth with a neutral detergent.



Brush away dust on the plug with a dry cloth.

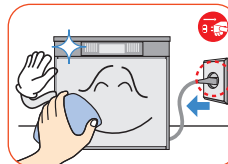

Do not use chemicals like wax, benzene, alcohol, thinner, aromatic, or lubricant, etc.

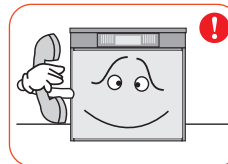

For special cleaning of inner part per year, contact to the service center.  
▶ If you don't clean the inside of incubator for a long time, dust can cause some trouble or a fire.



**Identification of Parts**

Serial NO is located on the upper front cover. (ex. RCM0000000) is a product specific number.

**Rcom MARU DELUXE MAX 190 / 380 / 1000** (\*Below is the image of MAX 190 model.)

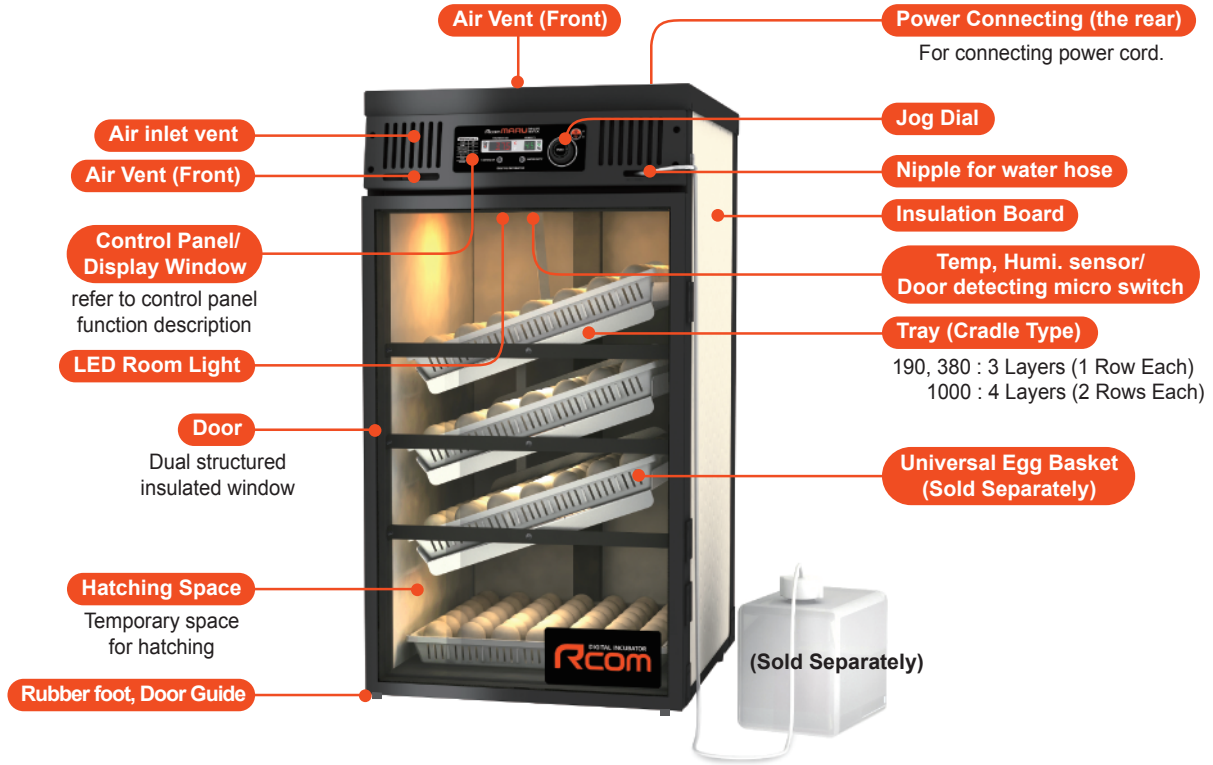

**Rcom MARU DELUXE MAX 100 / 200 / 300 / 500** (\*Below is the image of MAX 200 model.)

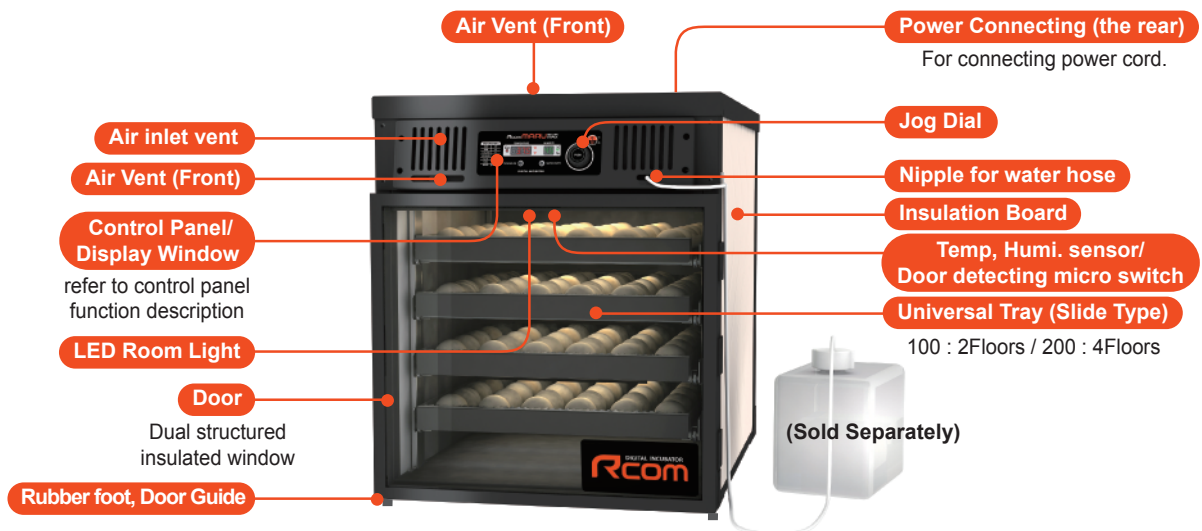

### Basic Components

#### Rcom MARU DELUXE MAX 190 / 380 / 1000



Manual



Power Cord

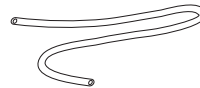

Silicon Tube : 1.5M (Diameter: Ø4\*6)



Driver

#### Sold Separately

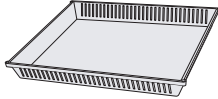

Universal Egg Basket

MARU 190 4EA  
MARU 380 8EA  
MARU 1000 20EA



ABS Divider

MARU 190 30EA  
MARU 380 60EA  
MARU 1000 160EA

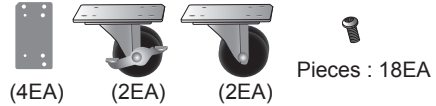

Spinning Wheel, Bracket

MARU 190 4EA  
MARU 380 4EA  
MARU 1000 4EA

Pieces : 18EA

#### Rcom MARU DELUXE MAX 100 / 200 / 300 / 500



Manual



Power Cord

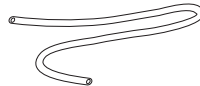

Silicon Tube : 1.5M (Diameter: Ø4\*6)



Driver



Lubricant

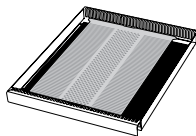

Universal Tray

MARU 100 2EA  
MARU 200 4EA  
MARU 300 3EA  
MARU 500 5EA



Aluminum Divider

MARU 100 14EA  
MARU 200 28EA  
MARU 300 30EA  
MARU 500 50EA  
\* Extra aluminum divider can be purchased separately

#### Sold Separately

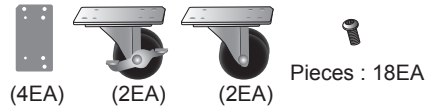

Spinning Wheel, Bracket

MARU 100 4EA  
MARU 200 4EA  
MARU 300 4EA  
MARU 500 4EA

Pieces : 18EA

**Name & Function of Operation Parts**

Rcom MARU DELUXE MAX 190 / 380 / 100 / 200 / 300 / 500

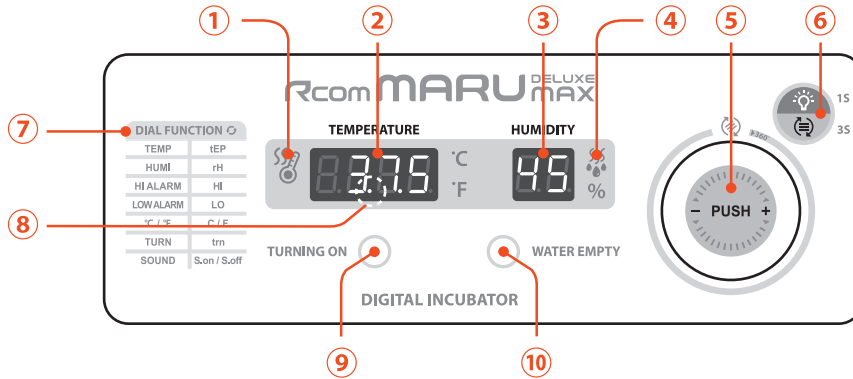

Rcom MARU DELUXE MAX 1000

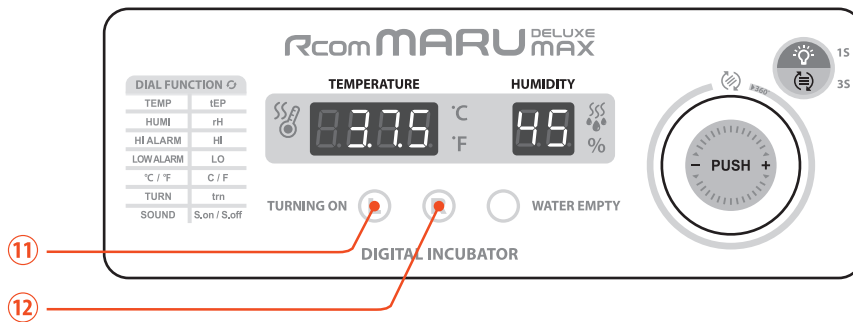

● **Names and components of each part**

- ① **Heater Operation Lamp** : Light on when working
- ② **Temp. Display** : Current Temperature Display
- ③ **Humidity Display** : Current Humidity Display
- ④ **Pumping System Operation Lamp** : Light on when working
- ⑤ **Jog Dial** : Press and turn around to left and right
  - Function setting mode will appear when pressed for 3 seconds
  - Temp. and humidity can be checked when pressed for 1 second
  - Turning the jog dial 360° will move the cradle and pressing it will stop ※ Cradle Type
- ⑥ **Room Light Button (1 second) / Horizontal eggs turning button (3 seconds) ※ Cradle Type / Forced egg turning button (3 seconds) ※ Slide Type**
- ⑦ **Function Table** : Function can be selected in order by using the jog dial
- ⑧ **Outage Notification** : Blinks during power outages.  
(Release button: press the jog dial once)
- ⑨ **Egg Turning Lamp** : Blinks during operation
- ⑩ **Water Supplement Lamp** : Blinks with water shortage ("Water empty signal" will be alarmed every 10 seconds)
- ⑪ **Turning on L Lamp** : Blinks while the left-side cradle working
- ⑫ **Turning on R Lamp** : Blinks while the right-side cradle working

### What is an Incubation Room? (Common)

The Incubation Room is a confined space for setting and operating an incubator efficiently. An Incubation Room environment has a considerable effect on hatch rate. Controlling the incubator environment is recommended; there should be little noise or vibration and constant temperature ranging upwards from 28°C(82.4°F) with small variation in temperature. For optimum performance, pay attention that your incubator isn't exposed to temperature drops compared with daytime. Do not directly exposed the incubator to sunlight during daytime. also, please incubator where direct wind from air-conditioner not to reach.

**!** If you set a high temperature, condensation will occur and may causes water to leak from the incubator and it which is not a technical problem. You need to keep temperature between 28°C (82.4°F).

### How to Install this Incubator (Common)

- ▶ Please set the incubator horizontally on a stable, tallish table (50[cm] or above)
- ▶ Ensure the incubator is completely level, so the door can close completely.
- ▶ Connect silicon tubing onto the nipple of incubator, and the other end of silicon tubing into a water container.

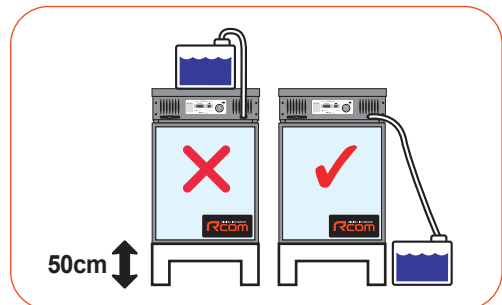

**!** Do not place water container on top of the incubator. It may flood the humidity unit.

**!** Using tap water or underground water instead of distilled water in this unit's humidification device will cause serious debris (scale) to develop. In this case, the inconvenience of frequent cleaning will occur and when left alone, may become the cause of malfunction or breakage. If you have any questions regarding such problems, please contact the place of purchase and failure of the device due to the consumer negligence (due to non-cleaning), even if it occurred with in the free A/S period, repair charges might occur when repairing . so use of distilled water is highly recommended.

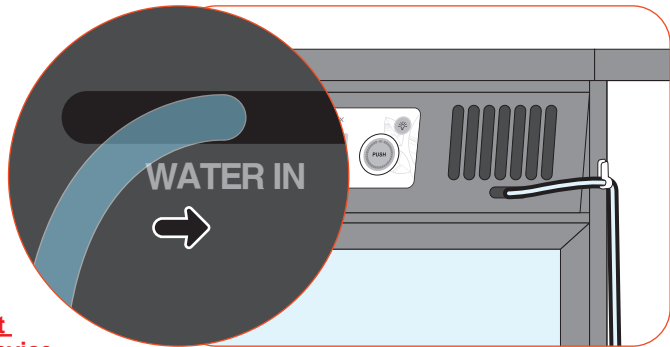

### [ Rotary wheel assembly method ] - Rotary wheels are sold separately

Sold Separately

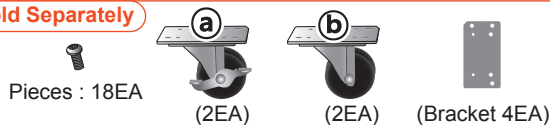

- ▶ (a) : the front - brake-type wheel x 2
- ▶ (b) : the rear - brake free-type wheel x 2
- ▶ Cautiously, lay the machine down :  
bracket-wheel-screw in sequence  
(a) for the front 2wheels, assemble brake-type wheel  
(b) for the rear 2wheels, assemble brake free-type wheel  
Once the assembly done, put up the assembled incubator with care.

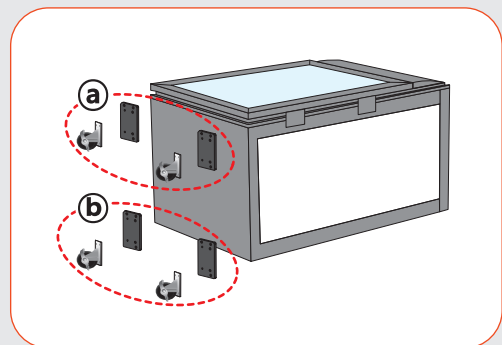

**!** The device can be broken or injured due to weight when setting up or laying down the machine, so remove the egg basket or trays inside the device before assembling.

#### Preparing for Incubation (190/380/1000)

- ▶ Organise eggs by size using the dividers. Be sure to fit eggs to space made by the two dividers.

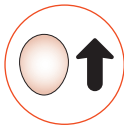

It is best to insert eggs towards the round part of the egg corner (air chamber side)

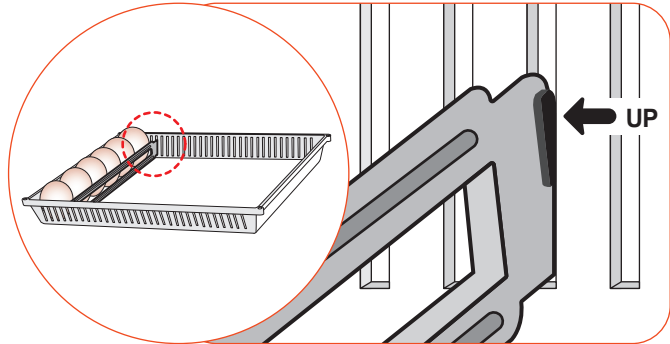

- ▶ Please make sure that the protruding part of the divider faces up, as shown in the figure.



More eggs will fit between the dividers, if sorted by similar size.



The eggs intended for incubation must be fertilized eggs.

- ⚠ Ensure eggs are vertical, not tipped to one side, when placed in the egg basket.

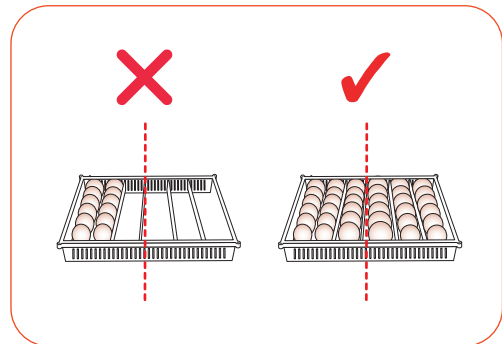

- ▶ Before placing egg baskets in the incubator, turn it off for your safety.

- ⚠ Be sure to close the door completely, if not, the temperature and humidity will not be controlled. Please check if the machine's floor is wet or not, it should be dry, otherwise the machine may not reach the normal temperature. (Do not place water container on top of the machine.)

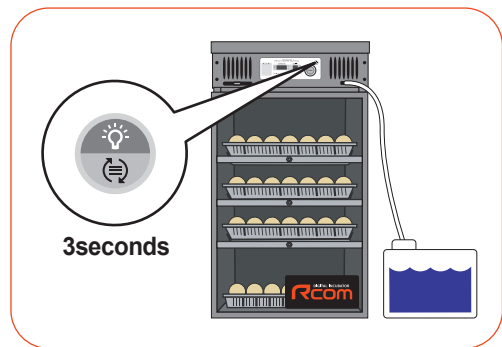

- ▶ Press the horizontal egg rotating button for 3 second to set the tray horizontally. (Close the door for safety)

- ⚠ For cradle type machines, if the egg basket comes out, it will obstruct the turning frame and egg-rotation will not occur so please be cautious and secure the egg baskets well.

- ⚠ Test the incubator to be sure that the incubator works without any problem before placing eggs in the incubator. Please ensure you remember how to use the machine and maybe re-read instructions.

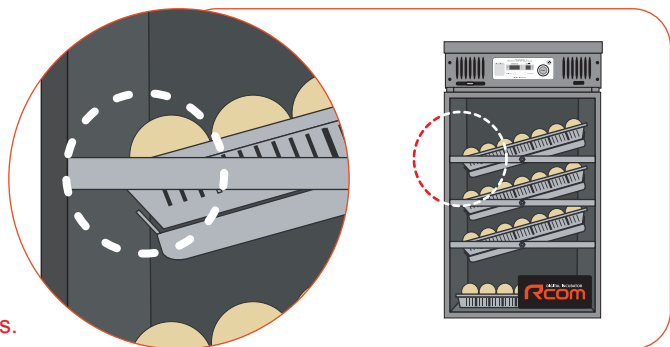

## 3. Incubation

### (1) Preparation for Incubation / How to Start Incubation

# MARU

#### Preparing for Incubation (100/200/300/500)

#### [ Egg tray assembling method ]

- ▶ Remove the cable ties fixed to both sides of the egg tray of each shelf (shown in figure ③ below).
- ▶ Before supplying power, make sure that the filler bar (shown in figure ④ below) located in the universal tray slide plate is inserted in the middle of the carrier frame (shown in figure ③ below).

**⚠** If cable ties are not removed, egg-rotation problems or malfunctions may occur.

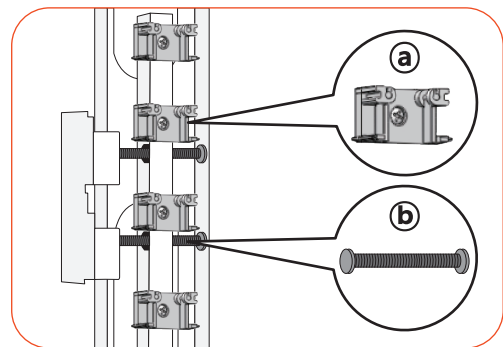
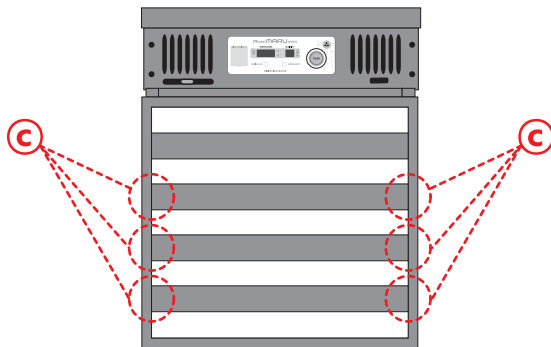

#### [ Egg Rotating Device ]

① : Carrier Frame ② : Moving Screw

- ▶ 2 frame fillers are installed on one carrier frame.
- ▶ The Carrier filler shown in figure below is factory assembled so no assembly is required.

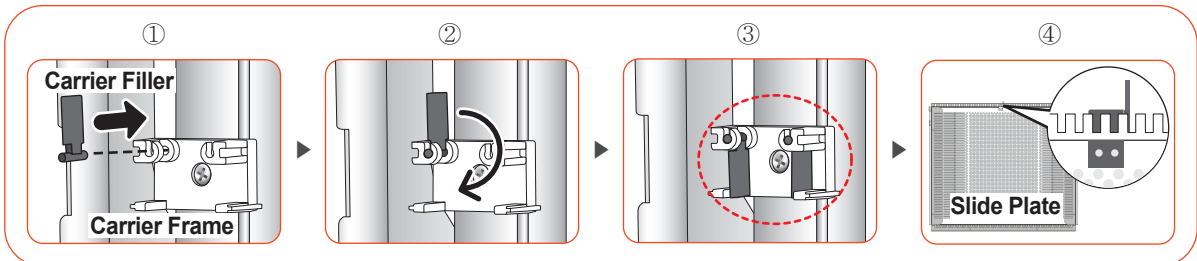

**⚠** If the door isn't completely closed, the temperature and humidity might not be controlled, so be careful.  
If water is on the machines floor, it will not reach operating temperature.  
(Do not place the humidifier water tank on top of the machine.)

**Tip** More eggs could be inserted if sorted by similar size.

**Tip** The eggs intended for incubation must be fertilized eggs.

- ▶ A slight gap (about 2mm) is required, between egg and aluminum divider (as shown in the figure), this allows smooth egg turning.

**⚠** Please turn on the device and make sure that all functions are properly operating before putting in the eggs.

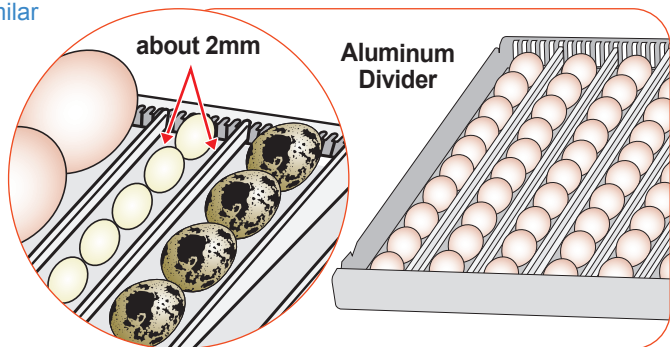



#### How to Start Incubation (Common)

- ▶ When the power cord is plugged in and turned on the digits on the temperature and humidity FND appears, then Temperature and Relative Humidity will increase a little. (Their default value is respectively : 37.5°C (99.5°F) and RH 45%) A initial smell may be noticed this is to be expected.

**⚠** Do not connect power supply before the incubator is assembled completely.  
Risk of electric shock.

- ▶ Please check and refill distilled water every 2 days during incubation. Or as needed (If the water tank is small, please check every day.)

**⚠** If you use the incubator without adding humidification water or intend to incubate eggs at low humidity under RH 20%, you must stop the humidification function. Please turn off the humidity function if there is no water available otherwise the humidity unit will fail, making the machine unuseable. When using this function (disabled humidification) the Water Empty Led and the related alarm from the control panel are turned off. [Refer to the page 16]

※ To turn off the Humidification Function : Set humidity under RH 20%.

**⚠** Using tap water or underground water instead of distilled water in this unit's humidification device will cause serious debris (scale) to develop. In this case, the inconvenience of frequent cleaning will occur and when left alone, may become the cause of malfunction or breakage. If you have any questions regarding such problems, please contact the place of purchase and failure of the device due to the consumer negligence (due to non-cleaning), even if it occurred with in the free A/S period, repair charges might occur when repairing . so use of distilled water is highly recommended.

- ▶ For the first two seconds, after power on, FND blinks and the pump starts working (until the internal humidification water tank is filled : In case of water shortage the pump runs for 2min.) and for another one second, the version number will be displayed on FND.



- ▶ After version indication, buzzer sounds for about 15sec. At the same time, present temp. & humidity is displayed and power failure alarm indication ( " . " ) Ⓐ is blinking.

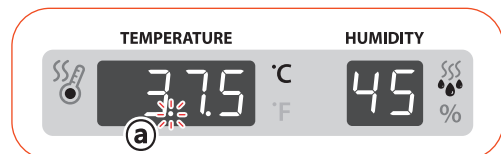

- ▶ Press Jog dial in to remove buzzer and alarm indication. (Buzzer will cease automatically after 15sec.)

※ Power Outage notification: If power fails during operation or the power cord is reconnected after being removed for some reason Ⓐ ( " . " ) will blink.

**Tip** Quick Start : If you just connect the power plug and turn power on, the machine automatically starts incubation with factory setting. [Factory setting: Temperature 37.5°C (99.5°F), Humidity RH 45%]

- ▶ Current temperature and humidity will appear on the display panel and it will slowly reach the set value after 1~2 hours.

※ The artificial intelligence system memorizes and classifies ambient conditions to assist in keeping optimum temperature; temperature can move up slowly at first stage.

### Egg Turning (190/380/1000)

- ▶ 3 days before hatching, please be sure to stop egg turning in tray and remove dividers from the trays. [Refer to the page 18]

⚠ Be careful! Chicks might get caught in the turning cradle if the egg trays are located out of frames i.e not correctly located **(b)**, this will cause problems for egg turning.

- ▶ How to align trays horizontally : Press (  ) button for 3 seconds to align.

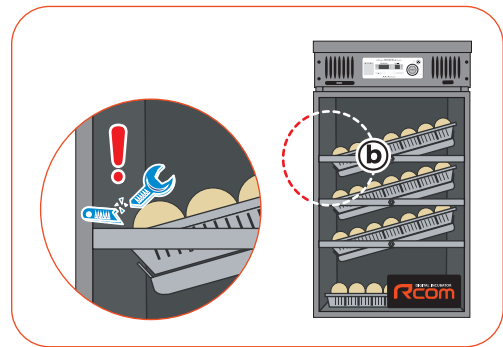

- ▶ Forced egg tray turning method: When in need of adding extra eggs to turn trays during incubation, turning the jog dial (360°) will start the forced turning and pressing the jog dial once momentarily will stop turning.

※ For MAX 1000, Turning L or R lamp illuminated, indicates which side cradle is turning.

⚠ It is recommended to hatch in special hatching room. Hatching chickens in a Incubator are exposed to the risk of falling from egg trays or being caught in mechanisms which may cause their death occasionally. Please don't forget to turn off the turning function during hatch. [Hatching separately in a specialist hatching machine is recommended, i.e the Rcom Hatcher & Brooder – Rcom Maru H&B 380, in this may your incubator is easier to maintain, hatching chicks are separated from incubating eggs (good health)]

**Egg Turning (100/200/300/500)**

▶ **Make sure you stop egg turning and remove the dividers 3 days prior to hatching. [Refer to the page 19]**

▶ Forced egg tray turning method : By pressing forced turn button (  ) for 3 seconds, turning will occur once.

**!** It is recommended to hatch in special hatching room. Hatching chickens in a Incubator are exposed to the risk of falling from egg trays or being caught in mechanisms which may cause their death occasionally. Please don't forget to turn off the turning function during hatch. [Hatching separately in a specialist hatching machine is recommended, i.e the Rcom Hatcher & Brooder – Rcom Maru H&B 380, in this may your incubator is easier to maintain, hatching chicks are separated from incubating eggs (good health)]

**Tip** It is recommended that turning should be stopped 3 days before hatching day.

- ▶ The Rcom Maru sliding type model allows each layers egg turning to be separately turned off.
- ▶ By slightly pulling the handle of the each layer forward, as shown in the figure, egg turing function in the corresponding layer can be set to OFF.
- ▶ Try to balance weights egg numbers and weight in egg trays to avoid straining the machine.

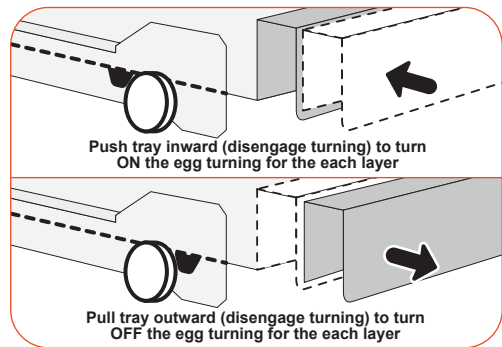

**[Good example for stopping turning of each layer] o : turning, x : Stop turning**

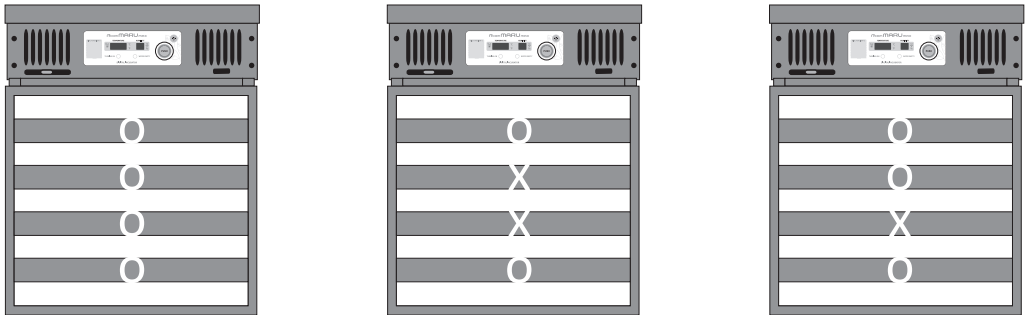

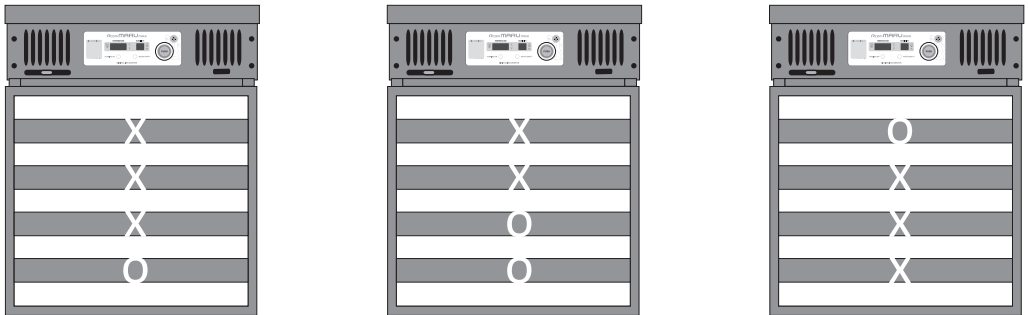

**[Bad example for stopping turning of each layer] o : turning, x : Stop turning**



**Humidification (Common)**

- ▶ All kinds of bird need over RH 65% humidity during the period prior to hatching.
- ▶ How to turn humidification off : When you don't need the humidification function with your working incubator, you can turn off by setting under RH 20% in the humidity setting mode. The mark "--" appears on FND and the humidity function stops. [Refer to the Page 16]
- ▶ Indication of water shortage : When the sensor detects low water level, water empty lamp is turned on. Lasting water shortage causes turning water empty lamp on, blinking of humidity working lamp and alarm ringing.
- ▶ Pumping Motor Test Method: During the operation of the machine, pressing the jog dial 3 times shortly will operate the pump motor.

 In case of water shortage, it works. When the inside of the incubator is filled with water, the pump motor works for 0.5 second. (Check motor working sound)

 Please turn off the humidity unit if the unit is empty water otherwise, humidity unit will be broke or you may not no longer use the unit. So please turn off the humidity unit. [Refer to the page 16]

 **Using tap water or underground water instead of distilled water in this unit's humidification device will cause serious debris (scale) to develop. In this case, the inconvenience of frequent cleaning will occur and when left alone, may become the cause of malfunction or breakage. If you have any questions regarding such problems, please contact the place of purchase and failure of the device due to the consumer negligence (due to non-cleaning), even if it occurred with in the free A/S period, repair charges might occur when repairing , so use of distilled water is highly recommended.**

**How to Terminate Incubation (Common)**

- ▶ No power switch for the incubator. The power cord should be unplugged to turn the incubator off after hatching.
- ▶ Rcom MARU do not need to be initialized after hatching. When you need the same condition as the previous set, all you need to do is to plug in your incubator.

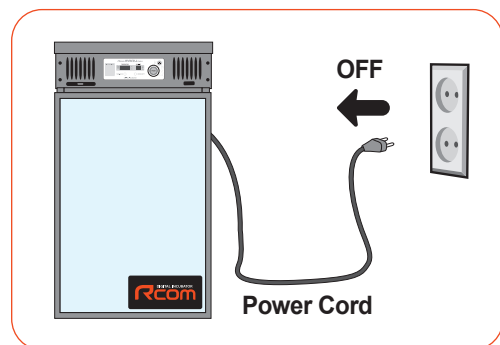

#### Humidity and Condensation principles, Air Flow considerations (Common)

- ▶ When hatching, humidity should be relatively high to prevent the thin membrane from drying out or hardening before hatching.
- ▶ When hatching, it's recommended not to open the door often. This is because if you open the door often humidity will be rapidly decreased and it will take a long time to regain the proper humidity.
- ⚠ **Incubator internal temperature is 37.5°C (99.5°F) or more, and hatching room temperature is below 28°C, in that case, RH 70% humidity is may not be able. The difference of ±5% humidity value may occur from the humidity sensors difference, and there are no problems at hatching.**
- ▶ It's very important to maintain humidity higher 1~2 days before hatching than the early and middle incubation periods. Humidity requirements during incubation are RH 45~55% for waterfowl, RH 40~45% for poultry and RH 35~45% for parrot, in general. One day before hatching, all kinds of birds need about RH 65% humidity and sometimes need higher than that. However, in areas of high ambient humidity, lower levels of humidity may be needed during incubation.
- ▶ Air Controlling Lever : Outer fresh air can be flowed into incubator inside without affecting insulation. When eggs start hatching, open air controlling lever either fully or half-open.
- ▶ If the temperature where incubator installed is high, it will effects to incubator' setting temperature. In this case, you are able to adjust temperature by Air ventilation on the top of machine.

You can adjust  
Air Ventilation



1/4 open

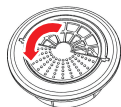

1/2 open



close

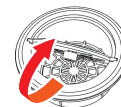

wide open

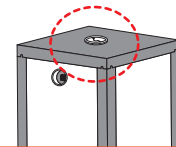

- ⚠ If you set high temperature, condensation will occur the near Air Vent and may causes licking water from the incubator and it is not a technical problem.

#### Post-Hatch maintenance (Common)

- ▶ Newborn birds are vulnerable to cold so it is essential to have a separate development room (brooding device) In case of developing (brooding) inside the incubator, the incubator can easily become contaminated with various bacteria which can become a major cause of reduction of hatching rate and various feather, dust, bark, manure and other pollutants can become the cause of incubator failure. In case of failure due to inappropriate usage can cause repair costs to occur even if it is within the free A/S period so purchasing of a separate development (brooding) is recommended. Instructions to build a simple development (brooding) room can be found on our homepage. ([www.Rcom.co.kr](http://www.Rcom.co.kr) → Rcom Study → Making a birdcage)

- ⚠ Do not developing chicks inside the incubator. It becomes the source of malfunction of the device and repair charges will rise even if it is within the free A/S period.



Generating Room : Space for hatching (breaking of the egg) and used 1~3 days before hatching  
(Rcom maru H&B 380)

Development (Brooding) Room : A device designed for newly hatched chicks to adjust to the environment by maintaining proper temperature and humidity for certain amount of days.  
(Rcom maru H&B / Rcom bird brooder & ICU)

- ▶ As there is some difference in chick feed for each kind of bird, so it's desirable to obtain useful information about the chicks before hatching.

#### Dew Condensation (Common)

Dew condensation is natural phenomenon which can be occurred when incubator inner temperature is big different from outer temperature. So, water can leak from the incubator during humidification, which is normal. Appropriate Incubator internal temperature is between 28°C (82.4°F).



## 4. MARU Function Settings

(1) Return to Factory Settings  
(2) Temperature and Humidity Settings

# MARU

### Return to Factory Settings (Common)

- ▶ This function is for return incubator to factory setting.
- ▶ Unplug power cord. Reconnect power plug whilst simultaneously pressing the jog dial. Then, "rSt AL" will be indicated in the display, now the MARU is returned to factory settings. (Default setting)

Factory Setting Display

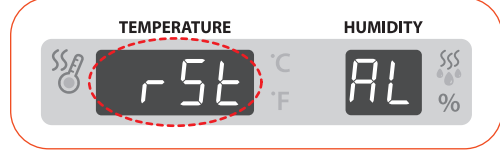

### Temperature Settings (Common)

- ▶ When jog dial is pressed for 3 seconds from the initial setting, "tEP" (Temperature) is displayed for 0.5 seconds and the temperature setting will blink.
- ▶ When the temperature setting is blinking, turn the jog dial to left or right to increase or decrease the temperature by 0.1°C. [Default Value: 37.5°C (99.5°F)]
- ▶ When the desired setting is reached, press the jog dial once to save the set temperature value, now next phase, humidity setting's "rH" (humidity), will display for 0.5 seconds on the display window and the set value will blink.

Step 1

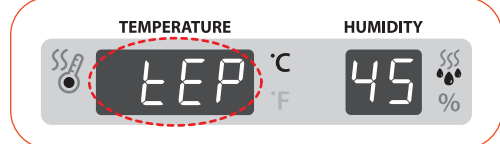

Step 2

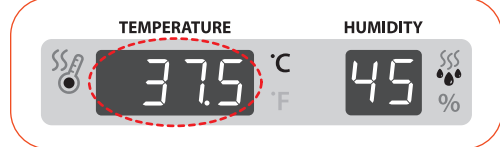

※ If you do not wish to change the setting values for the remaining functions in the next steps, press the jog dial for 3 second and the standard values will be entered, the SET display and menu will discontinue.

### Humidity Settings and Humidifier Device OFF method (Common)

- ▶ From the temperature setting, press the jog dial once and "rH" (Humidity) will be displayed for 0.5 second and humidity display will blink.
- ▶ When the humidity display blinks, turn the jog dial left or right to increase or decrease the humidity by 1%. [Default Value: RH 45%]
- ▶ If, when the humidify display is blinking, and you set the RH below 20%, (set by turning the jog dial to the left), the humidity function will now be "OFF" and will be displayed as (a) on the display panel.
- ▶ When the desired setting is reached, press the jog dial once to save the set humidity value and sequence will move to the next phase i.e Abnormal High Temperature alarm. "HI" (Abnormal High Temperature Alarm), will display for 0.5 seconds on the display window and the set value will blink.

Step 3

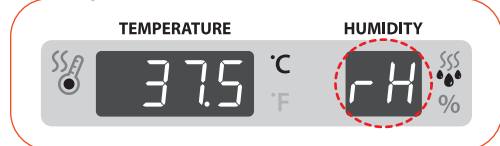

Humidity Function OFF

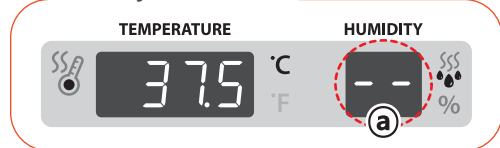

Step 4

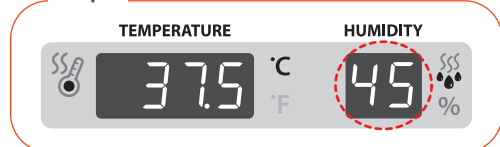

 The temperature and humidity level is optimized according to the international standard at the time of shipping. It could be recalibrated by the user if the user wishes to do so, but this is not recommended.

When in need of adjustment, please refer to our homepage ([www.Rcom.co.kr](http://www.Rcom.co.kr) → Information → User Manual Category) or contact the place of purchase. Commercially available thermometer and hygrometers may have drastic measurement deviations, so it is recommended to use thermometer and hygrometer designated for this purpose. [Designated Thermometer and hygrometer – Refer to Rcom Homepage]

※ If you do not wish to change the setting values for the remaining functions in the next steps, press the jog dial for 3 second and the standard values will be entered, the SET display and menu will discontinue.



#### The Abnormal High Alarm Settings (Common)

\* Max. abnormal temp. alarm limit (0.0 ~ 5.0°C Default Setting:2.0°C)



What is the abnormal high temperature alarm?

It is a function that lets the users know that the cabinet temperature increased due to unusual external temperatures, when the temperature of the incubating cabinet increases beyond the set value due to increased internal temperature, this alarm will ring along with the "HI" display and temperature difference (ex: 3 degrees). After that, even if the temperature returns to normal, the jog dial needs to be pressed to cancel the alarm, otherwise the alarm will continue to sound along with the blinking display.

- ▶ From the humidity setting, press the jog dial once and "HI" (abnormal High temperature alarm) will be displayed for 0.5 second and temperature display will blink.
- ▶ When the alarm set value is blinking, turn the jog dial left or right to increase or decrease the value by 1°C. [Default Value: 2°C (2°F)]
- ▶ When the desired setting is reached, press the jog dial once to save the set alarm value and the setup sequence will move to the next phase i.e Abnormal Low Temperature Alarm. "LO" (Abnormal LOw Temperature Alarm), will display for 0.5 seconds on the display window and the set value will blink.



※ It shows that the set temperature value is approximately 3°C (3°F) higher than the Maru incubator's incubation chamber(the Cabinet).

※ If you do not wish to change the setting values for the remaining functions in the next steps, press the jog dial for 3 second and the standard values will be entered, the SET display and menu will discontinue.

Step 5

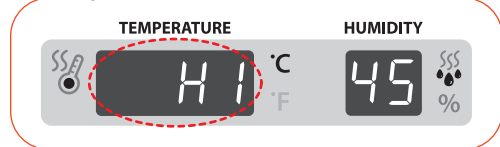

Step 6

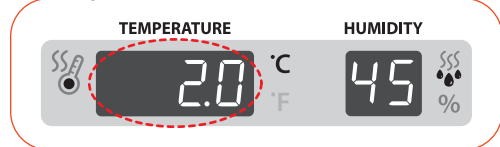

#### The Abnormal Low Alarm Settings (Common)

\* Min. abnormal temp. alarm limit (0.0 ~ -5.0°C Default Setting:-3.0°C)

- ▶ From the Abnormal High Temperature Alarm setting, press the jog dial once and "LO" (abnormal LOw temperature alarm) will be displayed for 0.5 second and the temperature display will blink.
- ▶ When the alarm set value is blinking, turn the jog dial left or right to increase or decrease the value by 1°C. [Default Value: -3°C (-3°F)]
- ▶ When the desired setting is reached, press the jog dial once to save the set alarm value and the setup sequence will move to the next phase, that is Celsius/Fahrenheit. "C,F" (Celsius/Fahrenheit), will display for 0.5 seconds on the display window and the set value will blink.



Abnormal Low Temperature :

In case of abnormal low temperature "LO" will be displayed on the display window and the procedure will be the same as the abnormal High temperature



※ It shows that the set temperature is 4°C (4°F) lower than the actual cabinet temperature of the machine.

※ If you do not wish to change the setting values for the remaining functions in the next steps, press the jog dial for 3 second and the standard values will be entered, the SET display and menu will discontinue.

Step 7



Step 8

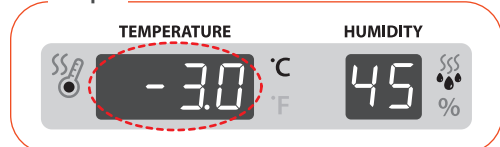

## 4. MARU Function Settings

(4) How to change between Centigrade and Fahrenheit Temperature units  
(5) Egg Turning options

# MARU

### How to change between Centigrade and Fahrenheit Temperature units (Common)

- ▶ From the abnormal LOW temperature alarm setting, press the jog dial once and "C.F" (Celsius/Fahrenheit) will be displayed for 0.5 second and LED for "C" will blink.
- ▶ By turning the jog dial left or right, LED light for "C" or "F" will blink accordingly [Default Value : °C]
- ▶ When the desired setting is reached, press the jog dial once to save the set value and the setup sequence will move to the next phase of egg turning. "trn" (Turn), will display for 0.5 seconds on the display window and the set value will blink.

Step 9

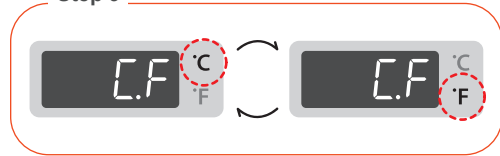

 °C = 5/9 (°F - 32)

- ※ If you do not wish to change the setting values for the remaining functions in the next steps, press the jog dial for 3 second and the standard values will be entered, the SET display and menu will discontinue.

### Egg Turning Options (190/380/1000)

- ▶ From the "C/F" change setting, press the jog dial once and "trn" (Egg turning) will be displayed for 0.5 second and the set value will blink.
- ▶ When the TURNING ON lamp is on, it means that egg turning function is turned "ON". At this time, it turning frequency.

Step 10

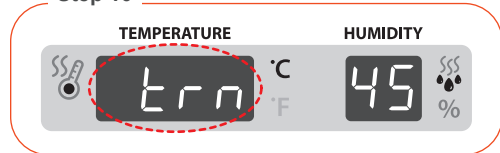

#### [ 190 / 380 ]

- ▶ By turning the jog dial left and right, "ON→OFF" will blink accordingly. [Default Value : ON]
- ▶ When ON is selected, egg turning cycle can be set in a 1 to 3 hour cycle. [Default Value : 1hr]  
After setting the desired turning frequency by turning the jog dial to the left or right, press the jog dial once to save the value and move on to the next setup step of "S.nd" (sound). "S.nd" will display for 0.5 seconds on the display window and the set value will blink.
- ▶ If OFF was selected, egg turning will stop and the setup sequence moves on to "S.nd" (sound), the next step, "S.nd" will display for 0.5 seconds on the display window and the set value will be displayed.

Step 11

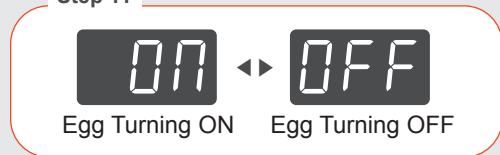

Step 12

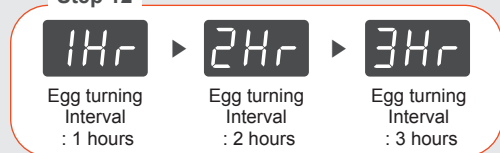

#### [ 1000 ]

- ▶ When you turn the jog dial to left, and to right it will appear in the order of "ON → OFF → L.ON → R.ON". [Default Value : ON]
- ▶ When ON (dual egg turning) is selected, both cradles rotate, and you can separately set each cradles' egg turning frequency to 1,2, or 3 hours. For trn1 (left cradle frequency setting) and trn2 (right cradle frequency setting).  
After setting the desired value by turning the jog dial to left or right, you can press the jog button once to save the setting and move on to the next step of "S.nd" (sound). "S.nd" will display for 0.5 seconds and set value will blink.
- ▶ If OFF was selected, egg turning will stop and the setup sequence moves on to "S.nd" (sound), the next step, "S.nd" will display for 0.5 seconds on the display window and the set value will be displayed.

Step 11

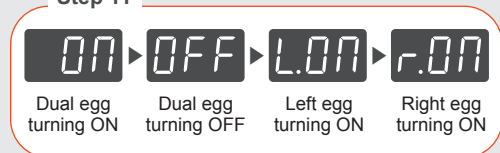

Step 12

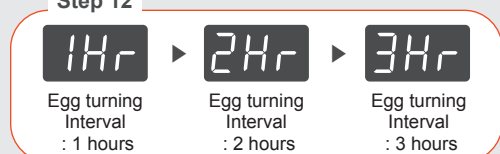

#### [ 1000 ]

- ▶ When L.ON (left egg turning) is selected, only the left cradle rotates, and when R.ON (right egg turning) is selected, only the right cradle rotates. You can set each egg turning intervals to 1, 2 or 3 hours for each cradle. After setting the desired value by turning the jog dial to left or right, press the jog button once to save the setting and move on to the next step of "S.nd" (sound). "S.nd" will display for 0.5 seconds and set value will blink.

**⚠** At hatch time, It is recommended to hatch in a special hatching room. Hatching chickens in an Incubator exposes them to the risk of falling from egg trays or being caught in mechanisms causing death. Please don't forget to turn off the turning function during hatch. [Hatching separately in a specialist hatching machine is recommended, i.e the Rcom Hatcher & Brooder – Rcom Maru H&B 380, in this may your incubator is easier to maintain, hatching chicks are separated from incubating eggs ( good health)]

※ If you do not wish to change the setting values for the remaining functions in the next steps, press the jog dial for 3 second and the standard values will be entered , the SET display and menu will discontinue.

#### Egg Turning Options (100/200/300/500)

- ▶ From the "C/F" change setting, press the jog dial once and "trn" (Egg turning) will be displayed for 0.5 second and the set value will blink.
- ▶ By turning the jog dial left or right, "ON→OFF" will blink accordingly. [Default Value : ON]
- ▶ When ON is selected, egg turning interval can be set to a 1,2, or 3 hour cycle. [Default Value : 1hr]  
After setting the desired setting by turning the jog dial to the left or right, press the jog dial once to save the setting and move on to the next step of "S.nd" (sound). "S.nd" will display for 0.5 seconds on the display window and the set value will blink.
- ▶ If OFF was selected, egg turning will stop and the setup sequence moves on to "S.nd" (sound), "S.nd" will display for 0.5 seconds on the display window and the set value will be displayed.

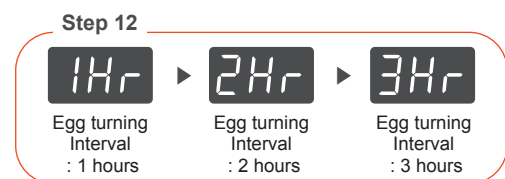
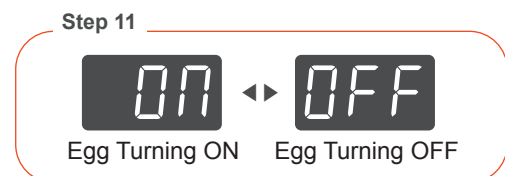
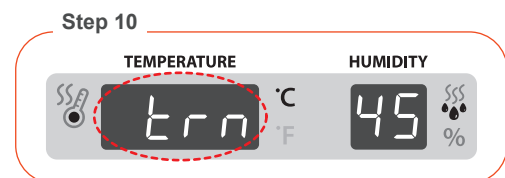

**⚠** At hatch time, It is recommended to hatch in a special hatching room. Hatching chickens in an Incubator exposes them to the risk of falling from egg trays or being caught in mechanisms causing death. Please don't forget to turn off the turning function during hatch. [Hatching separately in a specialist hatching machine is recommended, i.e the Rcom Hatcher & Brooder – Rcom Maru H&B 380, in this may your incubator is easier to maintain, hatching chicks are separated from incubating eggs ( good health)]

※ If you do not wish to change the setting values for the remaining functions in the next steps, press the jog dial for 3 second and the standard values will be entered , the SET display and menu will discontinue.

### Sound ON /OFF (Common)

▶ Moving on from the Egg turning settings, press the jog dial once and "S.nd" (Sound) will be displayed for 0.5 second and the set value will blink. [Default Value : ON]

▶ When you turn the jog dial to the left or right, "S.ON" ↔ "S.OFF" will be displayed respectively.

▶ After setting the desired setting, press the jog dial once to save the setting and the settings sequence is complete.

※ If you do not wish to change the setting values for the remaining functions in the next steps, press the jog dial for 3 second and the standard values will be entered , the SET display and menu will discontinue.

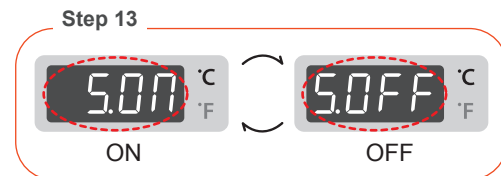

### Room Light ON/OFF Setting (Common)

▶ When you press the cabinet light button, you can ON/OFF the room light. [Default Value : OFF]

▶ When the door is open, the cabinet light turns on, when the door is closed, the light is OFF.

⚠ Leaving the lamp on for a long period of time is not good for incubation.

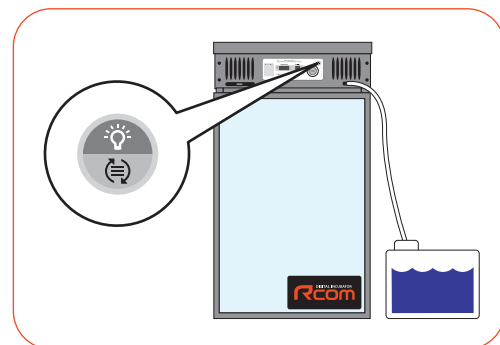

Instructions for Disassembling and Cleaning (Common)

**!** Power cord must be removed from the outlet of the machine.

- ▶ If you turn the incubator off and then leave the incubator door closed after high humidity incubation, accumulated moisture inside the incubator evaporates and sticks to electric and electronic circuits. This could cause problems, be sure to open the incubator door and completely remove moisture inside of incubator.

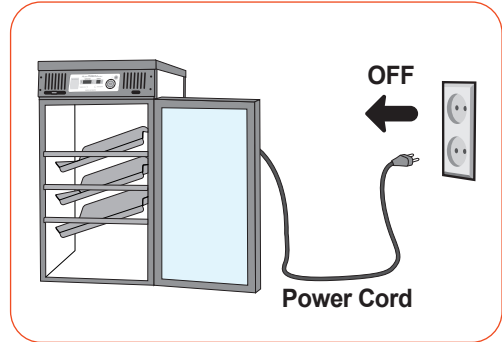

[ Cleaning the Controller Unit ]

- ▶ As shown in the picture, unscrew 6 screws located in the corners of the incubators cover with the screwdriver and open the cover.

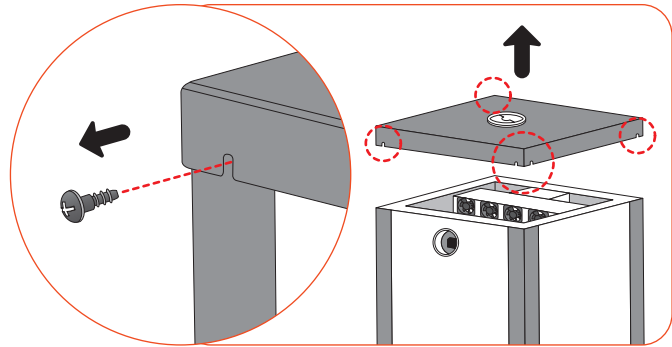

- ▶ Remove all the remaining water from the humidity unit.

**Tip** If a lot of dirty substance(scale) has formed in the humidifier unit, soaking it in vinegar overnight will neatly clean the humidifier unit.  
If a lot of scale has formed it is likely you are not using distilled water, please use distilled water as it prolongs incubator life.

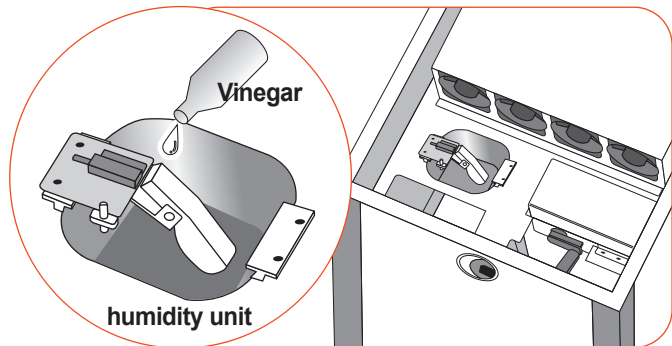

- ▶ dirty substance(scale) can form in the humidity unit and pan should be removed by using a vacuum cleaner, brush and/or further cleaning aided by vinegar.

**!** If there are any dirty substance(scale) in the humidifier unit and pan, it must be removed.

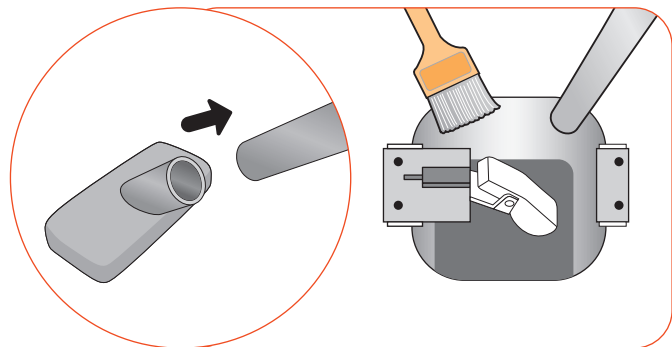

### [ Egg Rotator Cleaning method (100/200/300/500) ]

- ▶ For sliding type, after hatching, feathers and dust (dander) might be attached to the areas near carrier frame and moving turning screw, interfering with the egg turning capabilities.

**!** After hatching, remove the contaminants using brush and drop 1~2 drops of the lubricant to the moving screw portion, as shown in the picture, will lead to smooth device operation.

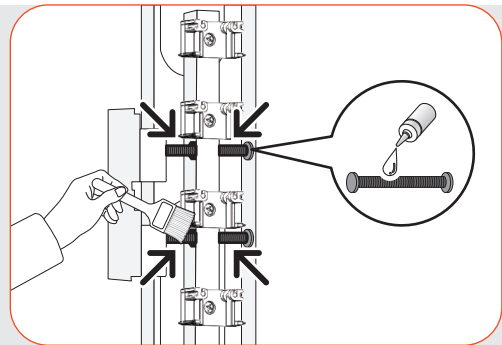

### [ Cleaning the Temperature, Humidity sensor ]

- ▶ This sensor part lies in upper part inside the incubator, behind the controller assembly but in front of the fan/heater unit. Occasionally, fluff, feathers, dirt (Dander) or water disturbs the accurate measurement of temperature & humidity. Please clean Dander away with a soft brush.

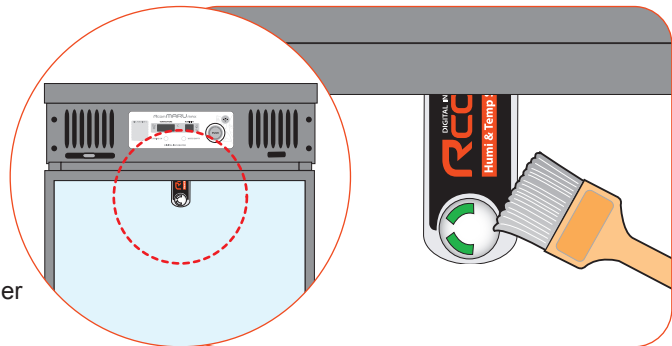

### [ Cleaning the Incubator Cabinet ]

- ▶ After hatching, remove the egg baskets and dividers (190/380/1000), universal trays and dividers (100/200) from the incubator, and clean the inside with a vacuum cleaner. Brush inside the cabinet again and then vacuum again, until satisfied that the incubator is clean.

**Tip** After several hatching, dust or bird feathers (Dander) can build up in the mechanisms, controller and humidity unit and cause incorrect operation or malfunction. So, ensure you clean the incubator carefully after each hatch. (The life span of the humidity unit can be reduced when used without cleaning.)

**!** Feather Dander and dust can clog up or foul circulation fans; this can make the fans noisy and also destroy the fans. It is very important to clean your incubator, for maintenance reasons and also to increase incubation success.

- ▶ Clean the egg baskets and dividers (190/380/1000), universal trays, dividers (100/200) with water and an antiseptic solution, and then dry naturally or operate incubator temporary to dry them.

**!** Be careful not to allow moisture into the power connecting parts on the rear of the incubator.

**!** Do not clean the incubator with benzene or thinner. There is a risk of transformation or dis-colorization.

- ▶ Reassemble in the reverse order of disassembling and store machine safely in a cool dry place.

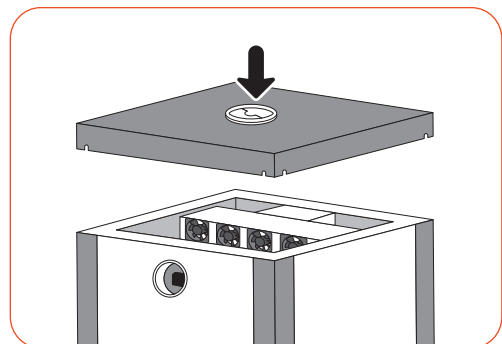



**Replacing Fuse (Common)**

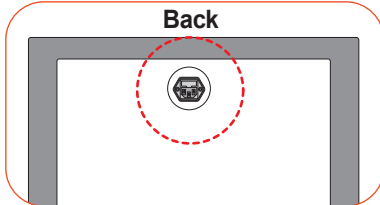

▶ Fuse is located at the top of power connection part on back side of incubator.

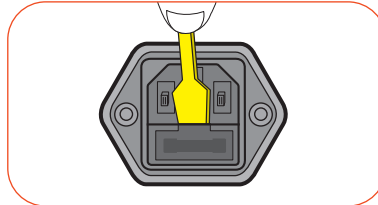

▶ When the fuse is damaged, remove the fuse at the inside below of power connection part, with screwdriver.

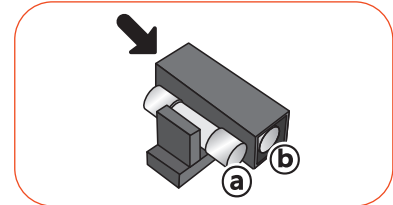

▶ Replace (a)(Used Fuse) fuse with (b)(Spare Fuse) fuse.  
For AC 100V use :  
250V 5.0A Ø5\*20mm  
For AC 230V use :  
250V 3.0A Ø5\*20mm

**General maintenance**

All our Rcom digital products of Autoelex Co., Ltd. are made by precision systems under strict quality control. But occasionally some defective products are found on the way of their distribution. If any problem occurs, then please contact Autoelex service center or distributors in your country. We will do our best to solve the problems, if any, for you. This product is designed in modular mode, so for its repair, if any, a qualified person can replace the part concerned with ease.

Troubles	Expected Causes (Possibility)	Countermeasures
<b>In case hatching rate is low</b>	<ul style="list-style-type: none"> <li>▶ When the egg is an unfertilized egg.</li> <li>▶ Getting infected by germs.</li> <li>▶ Wrong incubation setting.</li> <li>▶ Health condition of mother bird.</li> <li>▶ Improper egg turning.</li> </ul>	<ul style="list-style-type: none"> <li>▶ Inspect the egg to check possibility of egg surviving.</li> <li>▶ Disinfect the incubator.</li> <li>▶ Check all settings of incubator. Especially, check them focusing on the temperature.</li> <li>▶ Review care of health of mother bird.</li> <li>▶ Check if egg turning is normal.</li> </ul>
<b>When a chick hatches out earlier than expected or a deformed chick hatches out</b>	<ul style="list-style-type: none"> <li>▶ Setting temperature high.</li> <li>▶ Egg turning was not operating normally.</li> </ul>	<ul style="list-style-type: none"> <li>▶ Lower temp. setting of the incubator about 0.5°C (1°F) ex) 37.5°C (99.5°F) → 37.0°C (98.6°F)</li> <li>▶ Check if egg turning function is OFF.</li> </ul>
<b>When a chick hatches out later than expected</b>	<ul style="list-style-type: none"> <li>▶ Setting temperature low.</li> </ul>	<ul style="list-style-type: none"> <li>▶ Raise temp. setting of the incubator about 0.5°C (1°F) ex) 37.0°C (98.6°F) → 37.5°C (99.5°F)</li> </ul>
<b>When hatching dates are so different from each egg (When all chicks don't hatch out at the same time but over a long period)</b>	<ul style="list-style-type: none"> <li>▶ Eggs stored for different lengths of time.</li> <li>▶ Different incubation temperatures.</li> </ul>	<ul style="list-style-type: none"> <li>▶ Minimize the time to store egg properly.</li> <li>▶ Check Temperature difference in the incubator. (sunlight, temp of incubation room, etc.)</li> </ul>
<b>When intending to hatching various eggs at the same time</b>	<ul style="list-style-type: none"> <li>▶ Incubation days are different, so hatching rate falls down.</li> <li>▶ Eggs might be contaminated by chicks that hatched first.</li> </ul>	<ul style="list-style-type: none"> <li>▶ Mark hatching date on eggs and move them to other incubator(brooder) just on the marked date.</li> <li>▶ In case of putting in many eggs at the same time, it's convenient to prepare a spare incubator available as a Hatcher&amp;Brooder.</li> </ul>

### Troubleshooting(FAQ)

For more detailed self-diagnosis, see Rcom homepage "SELF DIAGNOSIS" category.

Circumstance	Items to be confirmed	Solutions
<b>No signs of power to the incubator.</b>	<ul style="list-style-type: none"> <li>▶ Check electric cord is properly connected.</li> <li>▶ Check if there is a power outage.</li> <li>▶ Check whether the plug is damaged.</li> <li>▶ Check the fuse.</li> </ul>	<ul style="list-style-type: none"> <li>▶ Connect the cord again.</li> <li>▶ Check the main socket with any other electric appliances.</li> <li>▶ Try to insert to another outlet.</li> <li>▶ Change the Fuse. [Refer to the page 23]</li> </ul>
<b>When temperature is too high / When temperature is too low</b>	<ul style="list-style-type: none"> <li>▶ Check your setting temperature.</li> <li>▶ Initialize the incubator. [Refer to the page 16]</li> <li>▶ Please check the bottom of machine is wet or not.</li> </ul>	<ul style="list-style-type: none"> <li>▶ Set the temperature as required.</li> <li>▶ Please remove moisture.</li> <li>▶ Please put the water tank on the floor and use.</li> </ul>
<b>Alarm sounds with "HI" indication (abnormal high temp.)</b>	<ul style="list-style-type: none"> <li>▶ Check if room temperature is too high.</li> <li>▶ Check if incubator is exposed to the direct rays of sun.</li> <li>▶ In case of lowering temperature.</li> </ul>	<ul style="list-style-type: none"> <li>▶ Adjust room temperature 28°C (82.4°F)</li> <li>▶ Install incubator without the direct rays of sun.</li> <li>▶ Return incubator to factory setting. [Refer to page 16]</li> </ul>
<b>Alarm sounds with "LO" indication (abnormal low temp.)</b>	<ul style="list-style-type: none"> <li>▶ Check if room temperature is too low. (especially during night)</li> <li>▶ please check the bottom of machine is wet or not.</li> </ul>	<ul style="list-style-type: none"> <li>▶ Adjust room temperature 28°C (82.4°F)</li> <li>▶ Place thermometer inside of incubator and check if setting temperature is correct.</li> <li>▶ Please remove moisture.</li> <li>▶ Please put the water tank on the floor and use.</li> </ul>
<b>Humidity will not go high enough.</b>	<ul style="list-style-type: none"> <li>▶ Check your setting humidity.</li> <li>▶ Close the door again after checking.</li> <li>▶ Initialize the incubator. [Refer to the page 16]</li> <li>▶ Check if pumping is working. [Refer to the page 14]</li> </ul>	<ul style="list-style-type: none"> <li>▶ Supply water.</li> <li>▶ Check if silicon tube is blocked.</li> <li>▶ Set the humidity again as required.</li> <li>▶ Clean the humidity unit. [Refer to page. 21~22]</li> </ul>
<b>The machine makes some noise.</b> - A little noisy occurs from the inside of circulation fan.	<ul style="list-style-type: none"> <li>▶ Check if there is any hatching dust such as feather or eggs-shell in the incubator FAN.</li> <li>▶ A little noisy is not faulty.</li> </ul>	<ul style="list-style-type: none"> <li>▶ Remove power and then open maintenance cover to clean the FAN for air circulation. [Refer to page 21~22]</li> </ul>
<b>Egg-Turning fails to work.</b>	<ul style="list-style-type: none"> <li>▶ Check that the Egg-turning stoppage is not activated. &lt;190/380/1000&gt;</li> <li>▶ Check for contaminants in the cradle.</li> <li>▶ Make sure the egg turning basket is properly assembled.</li> <li>▶ Check that there are no foreign items on the egg turning tray. &lt;100/200&gt;</li> <li>▶ Check if egg turning plate is assembled correctly.</li> <li>▶ Check to see if the egg rturning for the each layer has stopped. [Refer to the page 13]</li> <li>▶ Check to see if the filler bar for the slide plate is located in the middle of the carrier filler. [Refer to the page 10]</li> </ul>	<ul style="list-style-type: none"> <li>▶ If you need to turn the eggs, you can manually re-start egg-turning.</li> <li>▶ Clean the contaminants.</li> <li>▶ Further push in the egg basket.</li> <li>▶ Cancel the egg turning for each layer. [Refer to the page 13]</li> <li>▶ Check to see if the carrier frame filler is installed. [Refer to the page 10]</li> <li>▶ Lubricate the vertical gear.</li> </ul>
<b>Dew foams in the incubator.</b>	<ul style="list-style-type: none"> <li>▶ Check the incubator is not placed too cold circumstances.</li> <li>▶ When you turn OFF incubator and then turn ON.</li> <li>▶ In case of setting high humidity.</li> </ul>	<ul style="list-style-type: none"> <li>▶ Adjust room temperature 28°C (82.4°F)</li> <li>▶ Dew condensation is a natural phenomenon and not a malfunction of the device. [Refer to the page 15]</li> </ul>
<b>Water leaks from the machine.</b>	<ul style="list-style-type: none"> <li>▶ Check if you did not place the water container on the incubator.</li> <li>▶ Check that the incubator placed on inclined surface.</li> <li>▶ Check if it is Dew condensation.</li> <li>▶ When set as high humidity.</li> <li>▶ When moved without taking out the water tank for the humidifier unit.</li> <li>▶ When humidity unit is not cleaned.</li> </ul>	<ul style="list-style-type: none"> <li>▶ Please put the water tank on the floor and use.</li> <li>▶ Place incubator under a level surface.</li> <li>▶ Dew condensation is a natural phenomenon and not a malfunction of the device.</li> <li>▶ Remove the remaining water in the humidity unit using pipettes or syringe.</li> <li>▶ Clean the dust(scale) from the humidifier unit after use.</li> </ul>

Test the incubator to be sure that the incubator works without any problem before placing eggs in the incubator. Please ensure you remember how to use the machine and maybe re-read instructions.

**Specification (190/380/1000)**

**1-1 Name : Rcom MARU DELUXE MAX 190 / 380 /1000**  
**1-2 Model : MX-190CD / MX-380CD /MX-1000CD**

NAME	CT Series Model No.	Capacities [Chick egg size]	Egg Turning Method	Egg turning angle [°]	Egg turning Interval [min]	Egg Turning ON/OFF per floors	Functional Ranger		
190	MX-190CD	168	Cradle Type	0, 90° (±5°)	0,60,120,180	1rows Egg Turning ON, OFF	Temperature: 20~42°C (68~107.6°F) Humidity: 20~70%		
380	MX-380CD	336	Cradle Type	0, 90° (±5°)	0,60,120,180	1rows Egg Turning ON, OFF	Temperature: 20~42°C (68~107.6°F) Humidity: 20~70%		
1000	MX-1000CD	840	Cradle Type	0, 90° (±5°)	0,60,120,180	1rows Egg Turning ON, OFF 2rows Egg Turning ON, OFF	Temperature: 20~42°C (68~107.6°F) Humidity: 20~70%		
NAME	CT Series Model No.	Humidification Device	Sold Separately	The number of Trays	Dimensions (WxLxH) [mm]	Weight [Kg]	Maximum electric power [W]	Average electric power [W]	
190	MX-190CD	○	Egg basket, ABS divider	3 floors×1row	440*419*823	25	440	70	
380	MX-380CD	○	Egg basket, ABS divider	3 floors×1row	440*838*823	30	440	70	
1000	MX-1000CD	○	Egg basket, ABS divider	4 floors×2row	816*963*823	53	440	70	

 **We are not allowed to extend warranty therefore we ONLY provide 1 year warranty service. If you do not register, we provide limited warranty service for 1year based on factory releasedate.**

 **You will be asking for service charge if you are in below cases.**

- 1. Broken or Problem caused by 'No cleaning' or 'Improper handling'**
- 2. Broken or problem caused by 'Not using distilled water'**
- 3. Broken or problem caused by 'Trying Bird hatching in incubator'**  
(Please don't try bird hatching in incubator. Please use Hatcher during bird hatching.)
- 4. Broken or problem caused by 'Wrong controlling(Using)'**
- 5. Broken or Problem caused by using the machine out of User's Manual.**
- 6. Broken or problem caused by 'Customer's mistake or fault'**

#### Specification (100/200/300/500)

1-1 Name : Rcom MARU DELUXE MAX 100 / 200 /300 / 500  
 1-2 Model : MX-100SD / MX-200SD / MX-300SD / MX-500SD

NAME	ST Series Model No.	Capacities [Chick egg size]	Egg Turning Method	Egg turning angle [°]	Egg turning Interval [min]	Each-Story Egg Turning ON/OFF	Functional Ranger
100	MX-100SD	96	Slide Type	0,180° (±5°)	0,60,120,180	○	Temperature: 20~42°C (68~107.6°F) Humidity: 20~70%
200	MX-200SD	192	Slide Type	0,180° (±5°)	0,60,120,180	○	Temperature: 20~42°C (68~107.6°F) Humidity: 20~70%
300	MX-300SD	288	Slide Type	0,180° (±5°)	0,60,120,180	○	Temperature: 20~42°C (68~107.6°F) Humidity: 20~70%
500	MX-500SD	480	Slide Type	0,180° (±5°)	0,60,120,180	○	Temperature: 20~42°C (68~107.6°F) Humidity: 20~70%
NAME	ST Series Model No.	Humidification Device	The number of Trays	Dimensions (WxLxH) [mm]	Weight [Kg]	Maximum electric power [W]	Average electric power [W]
100	MX-100SD	○	2 floors	484*637*414	19	440	70
200	MX-200SD	○	4 floors	484*637*573	26	440	70
300	MX-300SD	○	3 floors	730*700*570	44	440	70
500	MX-500SD	○	5 floors	730*700*760	52	440	70

**We are not allowed to extend warranty therefore we ONLY provide 1 year warranty service. If you do not register, we provide limited warranty service for 1year based on factory releasedate.**

**You will be asking for service charge if you are in below cases.**

1. Broken or Problem caused by 'No cleaning' or 'Improper handling'
2. Broken or problem caused by 'Not using distilled water'
3. Broken or problem caused by 'Trying Bird hatching in incubator'  
(Please don't try bird hatching in incubator. Please use Hatcher during bird hatching.)
4. Broken or problem caused by 'Wrong controlling(Using)'
5. Broken or Problem caused by using the machine out of User's Manual.
6. Broken or problem caused by 'Customer's mistake or fault'

**Rcom Incubator Series**

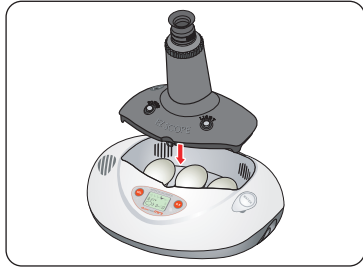

**Rcom PRO MINI (PX-03)**

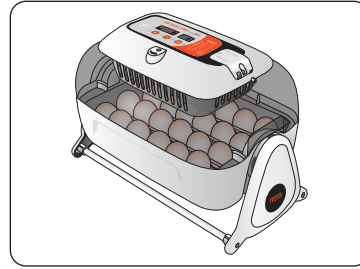

**Rcom KINGSURO MAX 20 (MX-SURO)**

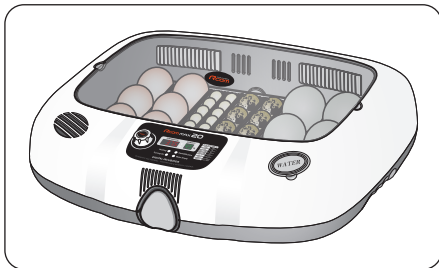

**Rcom MAX 20 (MX-20D)**



**Rcom Bird Brooder&ICU (MX-BS500)**

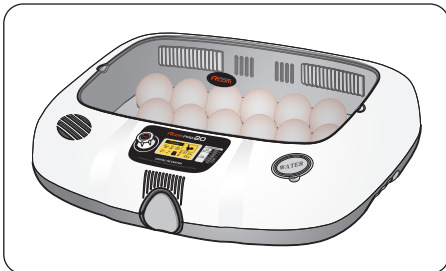

**Rcom PRO 20 (PX-20D)**



**Rcom MARU DELUXE H&B (MX-380HBD)**

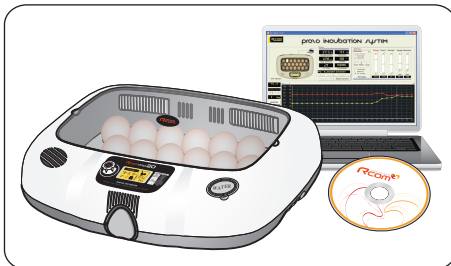

**Rcom USB 20 (UX-20D)**

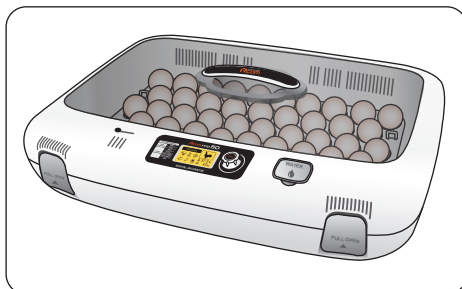

**Rcom PRO 50 (PX-50D)**



**Rcom DIGILOG (PX-V1)**



**Rcom DIGILOG2 (PX-V2)**

Rcom is designed for user's easy and convenient use.  
It can be changed without notice for improvement in performance,  
design, treatment, and software, etc.



[www.RcomCo.com](http://www.RcomCo.com)



**North America Sales & Service**

[www.RcomCo.com](http://www.RcomCo.com)

**MANUFACTURER**

**AUTOELEX CO.,LTD.**

● OFFICE : [F1] Deogam 612 Juchon Gimhae Gyeongnam 621-843 Korea  
[F2] 3, Yanggeun-ro 287beon-gil, Yangpyeong-eup,  
Yangpyeong-gun, Gyeonggi-do, Korea

Rcom is the Best Design with High Quality, Value, and Performance!